

# Instruction Manual

*for*

**POWER  HAND<sup>®</sup> 3**

**20,000RPM Motor Assembly**

**Model: PH3 20X**

**#510-3331**



**Gesswein<sup>®</sup>**  
The Right Tools

## Introduction

The Gesswein Power Hand 3 M-20X Rotary Motor is engineered and manufactured to a high degree of precision and will give you many years of trouble-free service. Backed by a limited warranty that covers wear parts for 90 days and overall balance of parts for six months.

This DC electrically driven rotary motor is designed to be used with the Power Hand 3 Controller (#510-3300). For use with Gesswein Power Hand 2X controllers, the PH3 adaptor (#510-3304) is necessary to connect the 5 prong motor plug to the 3 prong controller receptacle. Controllers convert the Alternating Current (AC) power supply to a variable Direct Current (DC) by means of an I.C. "transistorized" automatically controlled circuit.

The Gesswein Power Hand 3 rotary motor series consists of six motors and eight head assemblies with maximum operating speeds ranging from 8,000 to 55,000rpm. The maximum RPM speed is indicated on each motor case housing.

To connect Power Hand 3 handpieces to Power Hand 2X controllers, use the PH3 Adaptor 5 to 3 prong reducer plug. #510-3304.



**2**

## 1. Accessories

### Included Accessories

**A.** Two Carbon Brushes (reorder #510-0169)

### Optional Accessories

- A.** Handpiece Extension Cord (#510-3380): adds 9 feet, or almost 3 meters, to the rotary handpiece cord
- B.** Handpiece Cradle Rest (#510-1130): provides a safe holding place for the rotary handpiece when not in use
- C.** PH3 Variable-Speed Foot Rheostat (#510-3306)
- D.** 3mm Collet (#501-0106)
- E.** Reducing Collets: 1/8" to 3/32" (#816-1501), 1/8" to 1/16" (#816-1502), 3/32" to 1/16" (#816-1503), 3mm to 3/32" (#816-1504), 3mm to 1/16" (#816-1505)

## 2. Parts Nomenclature

1. Test Rod
2. Collet
3. Head Cover
4. Collet Release Ring
5. Motor Connecting Ring
6. Motor Housing
7. Motor Cover
8. Motor Cord with 5-prong plug
9. On/Off Switch

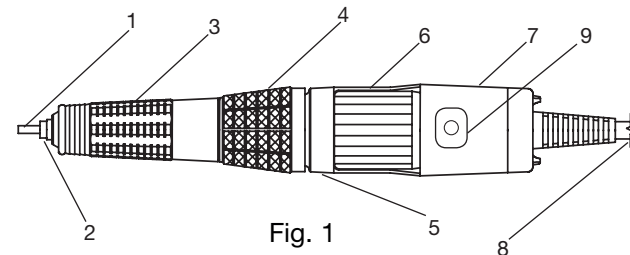

Fig. 1

**3**

### 3. PH3 On/Off motor switch

All Power Hand 3 rotary motors feature a convenient on/off motor switch (Fig. 2) for easy access to start/stop the motors. The Power Hand 3 On/Off motor switch will only function when connected to the Power Hand 3 controller. When connected to a Power Hand 2X controller (via the PH3 adaptor plug), the On/Off motor switch will have no affect.

Simply press the On/Off motor switch to start or stop the rotary handpiece. Be careful not to push the On/Off motor switch when changing collet chuck or any tools.

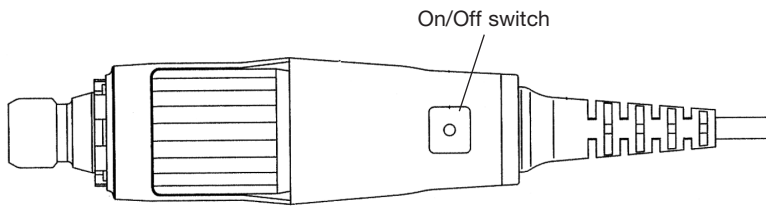

Fig. 2

### 4. Operating Procedure with Power Hand 3 Controller

With your rotary handpiece fitted with a selected tool, connect the Gesswein Power Hand 3 Controller to an electrical supply and the handpiece to the A motor or B motor output socket.

Put the Controller Main Switch to the "ON" position, which lights up the LED lights of controller. Then select the A motor or B motor button depending on which socket the handpiece is plugged in to. Check to make sure the desired rotational direction is selected on the Fwd./Rev. button. Then press the START/STOP button to supply power to your handpiece. RPM speed is adjusted by the round dial in the center. It is always best to start at minimum RPM and then increase to the desired RPM speed.

A Load Indicator light is located on the front panel of the PH3 Controller with 8 steps of LED lights from green to yellow to red. The display lights up as force is being applied to the handpiece. For best results and long life, stay within the green.



## 5. Precautions

- A.** Before operating your handpiece, be sure that the Collet Release Ring is in the “S” or secure position. Failure to do so (referred to as “locked rotor condition”) will cause the motor to stall and could possibly cause motor damage.
- B.** Do not attempt to change tools or rotate the Collet Release Ring while the handpiece is running. This action will stop the motor abruptly, cause parts damage, and could also possibly cause motor damage.
- C.** During use, avoid stalling the motor by pushing too hard on the work tool or by exceeding the torque capacity of the handpiece motor.
- D.** The Gesswein Power Hand 3 Rotary Handpiece is designed not to overheat with normal use. It can be used continuously and will provide efficient, longlife performance if you apply just enough machining and polishing pressure to maintain full motor speed.
- E.** The  $\frac{3}{32}$ " (2.35mm),  $\frac{1}{8}$ " (3.2mm) and 3.0mm collets are manufactured to accept  $\frac{3}{32}$ ",  $\frac{1}{8}$ " and 3.0mm  $\pm$  0.0008" shank tools respectively. Use only tools that correspond to the collet size being used.
- F.** Do not use your handpiece in water or oil, and never allow any oil, water or other fluids, dirt, or wood dust to enter the inner casing. Failure to keep foreign matter out of the inner casing will cause damage to the ball bearing assemblies.
- G.** Do not subject the power cord on the handpiece to sharp bending or rough treatment. Such treatment could break the cord wires or damage the male connecting pins and female cord connectors.
- H.** Be careful not to point the handpiece at any part of the body while it is running, particularly during startups.
- I.** Be careful when using Wire Burnishing Tools. **DO NOT USE THESE TOOLS AT SPEEDS FASTER THAN 14,000 -15,000RPM.** Each tool is made of individual piano wire. Operating a Wire Burnishing Tool at higher than recommended speed could cause the wire to come free from the hub.

## 6. Replacement of carbon brushes

Gesswein Power Hand 3 motors use a spring tension-type carbon brush assembly. The approximate life of these brushes is 800-1,000 hours. Use the set of two replacement carbon Brushes supplied with your handpiece when it becomes necessary to replace worn brushes. (Brushes should be changed when handpiece is not running at maximum speed, or if it sounds as though it's running out of gas.) Please note that in the event you must change the brushes, it is important that both be replaced at the same time. Replacement of only one carbon brush will cause motor damage.

### Instructions for replacing Carbon Brushes

1. Disconnect the handpiece from the controller.
2. Remove the screw on the back of the motor cover.
3. Detach the motor cord from the motor by grasping the motor cord and pulling backwards. Do not hold the motor cap when pulling backwards to avoid damaging the On/Off switch (Fig. 3).

Fig. 3

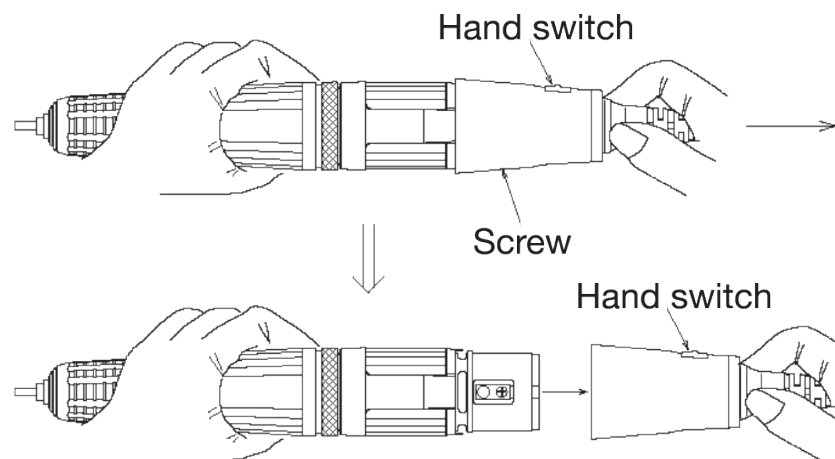

4. Remove the 2 carbon brush screws and take out the carbon brushes. Be careful not to lose screws.

5. Install the new Carbon Brushes and secure with screws (Fig. 4).

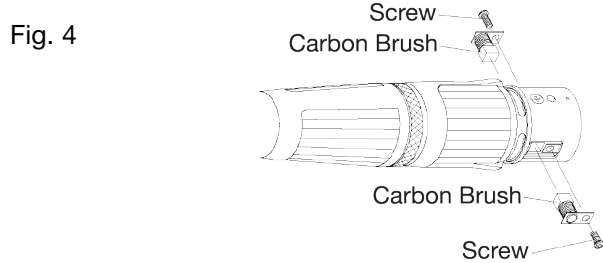

6. Gently push down the On/Off motor switch to free the motor cord from the motor cap. Be careful not to damage the On/Off motor switch. Then plug the motor cord back into the motor (Fig. 5)

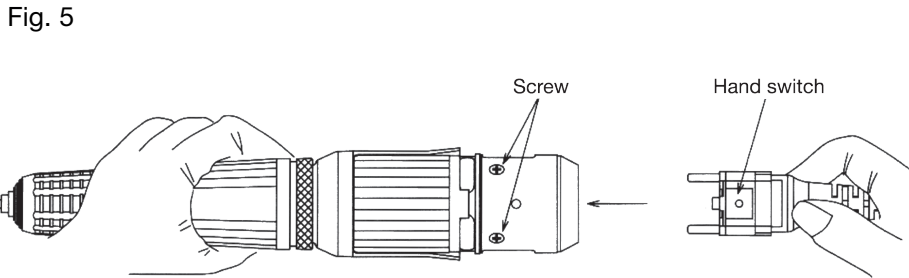

7. **Dust Removal** - From time to time, it will be necessary to clean excessive dust that accumulates in the motor cover. To remove this dust, remove the motor cap (see instructions for replacing carbon brushes to remove motor cap). If compressed air is available, use it inside the cover and the motor armature air cooling vent. If air is not available, remove excessive dust with a dry brush. If necessary, use a cloth moistened with detergent to clean the cover, and blow into the air cooling vents to clean around the armature. **DO NOT USE** any volatile liquid as a cleaner (i.e. paint thinner or alcohol).

Periodically cleaning the inner threads on handpiece collets will ensure their easy collet removal when changing sizes. Twist a clean rolled-up piece of tissue paper in and out of the threaded area.

8. Align the On/Off motor switch with the square hole of the motor cap, and gently insert motor cap (Fig. 6 & 7). Then insert the motor cap screw.

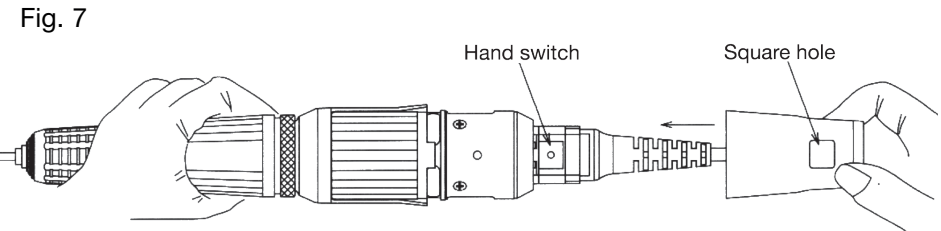
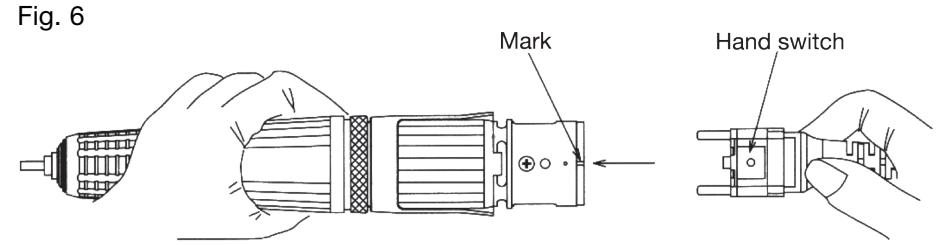

9. While the power is off, plug handpiece into controller. Please speed up gradually from minimum RPM and make sure nothing is abnormal with behavior.

10. **Lubrication** - Lubrication of your Gesswein Power Hand 3 Rotary Handpiece **IS NOT NECESSARY**, and you should **NOT** let oil or other fluids enter the Head Assembly (see Precautions).

## PH3 20X Motor Parts List

When ordering spare parts, always specify part#  
(or item# if applicable) and description.

Part#	Item#	Description
UM12A-318	896-0333	Motor Case
YSF21-103	896-0002	Countersunk Head Screw
S-10	896-0012	O-Type Rubber Ring
KS-107	896-0092	Metal Spacer
KS-601	896-0093	Teflon Spacer
KS-108	896-0094	Metal Spacer
1030ZZ	510-3073	Ball Bearing
KS-034	896-0095	Metal Spacer
KA10-114-BB	896-0334	Armature Completed
KA10-114	896-0335	Armature
KF-204A	896-0096	Dust Proof Collar
KF-201A	896-0097	Dust Proof Collar
830ZZ	510-3076	Ball Bearing
S-8	896-0098	O-Type Rubber Ring
HE5E-205	896-0099	Metal Rear Lid
ON08-201	896-0100	O-Type Rubber Ring
UM10-202	896-0336	Brush Side Lid
PKE60-101A	510-0169	Carbon Brush (set of 2)
YSP21-114	896-0337	Pan Head Screw
KE-548C	896-0102	(-) Terminal Plate
KE-548D	896-0103	(+) Terminal Plate
KE75-301	896-0338	Hand Switch Assembly
KE50-154	510-3382	Motor Cord with Plug
UM12A-780	896-0339	Motor Cap
YSF21-124	896-0325	Pan Head Screw
KP-615A	510-0180	Chuck Wrench

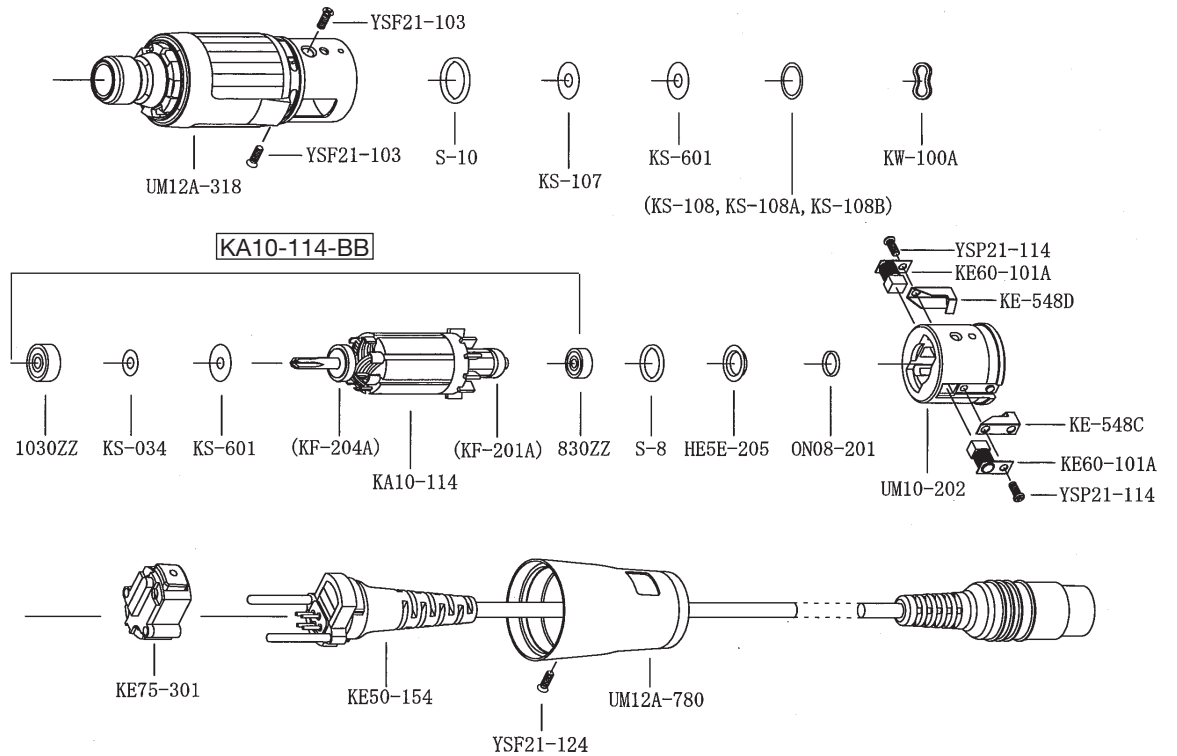



Power Hand 3 controllers and handpieces combine to create the most versatile finishing system in the industry, offering rotary, profiling and belt sanding action.

### **Power Hand 3 component selection:**

- PH3 controller
- Six motors (three high torque, two standard, and one high speed)
- A selection of 8 heads
- Two reciprocating profilers
- One side-to-side profiler
- Belt Sander

**Gesswein®**  
The Right Tools

201 Hancock Ave., Bridgeport, CT 06605, USA

☎ 1-203-366-5400 FAX 1-203-366-3953 Order toll-free 1-800-243-4466

Web site: [gesswein.com](http://gesswein.com) E-mail: [info@gesswein.com](mailto:info@gesswein.com)